

# Solar Powered Smart Agricultural Pump

Donet Tom<sup>1</sup>, Citharthan D<sup>2</sup>, M.Varatharaj<sup>3</sup>

<sup>1,2,3</sup> Department of EEE, Christ the King Engineering College, Coimbatore, Anna University Chennai, Tamil Nadu, 641104, India

## ABSTRACT

Solar energy is one of the best green energy generations in India. Solar power operated agricultural pumps are available in the market today. The problem is in the effective usage of solar power and energy saving. The DC output of the solar panels varies with respect to time, and it is unpredictable. So it is necessary to store solar power in the batteries. The problem comes when solar panels can able to generate more power and batteries connected to it are not able to store (100% charged condition) the solar power. Various researches have done to overcome the above problem by injecting the green energy generation to the electrical grid through smart meters. But, there are many problems by doing so. In this paper, the proposed unique solution will monitor battery level in batteries connected to solar panels and water level in water tank via internet. Once the battery level is 100% and if water level in water tank is below 98%, the agricultural pump will automatically turn on and utilize the solar power. If the water level in water tank is above 98%, the agricultural pump will automatically turn off and if battery is also charged for 100%, the controller will send a notification (For example- Battery is 100%, so please utilize the solar power) to the user. So that solar power can be utilize effectively by satisfying all the user needs. Users can save energy in the agricultural pump by sensing and analyzing information such as energy usage and tariff of agricultural pump with respect to date/time in dashboard via internet.

## 1. INTRODUCTION

Agriculture is the backbone of Indian Economy. **Green energy generation, effective energy utilization and energy saving in agriculture are inevitable.** Sensing the water level in water tank by water level sensor and displays it in dashboard via internet. If the water level is below 10% in water tank, then controller will automatically turn on the agricultural pump and if water level is more than 98% in water tank, then controller will automatically turn off the agricultural pump. Sensing the battery level connected to solar panels by sensor and displays it in dashboard via internet. If the battery level is 100% and if the water level is less than 98% in the water tank, then controller will automatically turn ON the agricultural pump. Once the water level is above 98% and the battery level is also charged for 100%, then controller will send a notification to the user to utilize the solar power. The water level and the battery level information from sensors will be uploaded to the cloud. From the cloud, it is able to monitor all the information in a real time via internet in dashboard. This will help to utilize the solar power effectively. The energy saving can be done by monitoring the energy usage and tariff with respect to date/time. Additionally it is able to turn on/turn off the agricultural pump through controller via internet.

## II. EXISTING METHODS

In BLDC Motor Driven Solar PV Array Fed Water Pumping System Employing Zeta Converter [1], the zeta converter is used to extract the maximum power from the solar photo voltaic array. This method eliminates phase current sensors and it avoids the fundamental frequency switching of the voltage source inverter, so it avoids the power losses due to high frequency switching. Therefore it does not need any additional control circuitry to control the motor speed. This system performance is does not affected by any dynamic conditions.

The Automatic Control of Agricultural Pumps Based on Soil Moisture Sensing [2] is the one method of automatic control of water pump. This method is used for the agricultural fields. In this system the water pump is turn on and off based on the soil moisture content. The soil moisture is sensed by the sensor and the speed of the motor is varied according to the sensor output.

Novel, Low cost Remotely operated smart Irrigation system[3] is used to supply water to the agricultural fields located at remote places. It is an automated embedded system device. It has a controller and sensors, according to the sensor output the controller controls the water pump. Sensors sense the water level, moisture content and temperature. The GSM module helps the farmer to monitor and operate the water pump far from the field.

Hybrid Water Pump System for Hilly Agricultural Site [4] is the water pumping system based on the siphon concept. It is a solar power operated system. The water pump is operated only at starting. Once the water flow starts it will continue by gravitational force. Flow rate sensor will monitor the flow rate if the rate is reduces then the pump will turn on automatically.

In Automatic Irrigation System Through Solar Power [5] the microcontroller will automatically control the water pump. With respect to the sensor output the controller controls the water pump.

**III. PROPOSED METHODE**

**3.1 Solution Architecture**

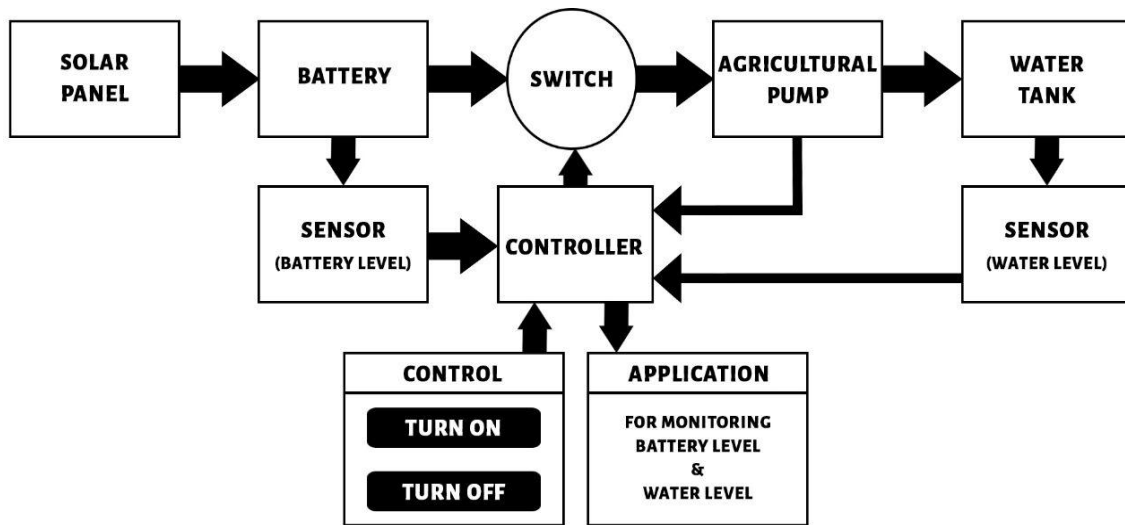

**Figure 1: Block diagram of Solar Powered Smart Agricultural Pump**

**3.2 Components:**

**Solar panel**

12 volt, 10 watt solar panel

**Solar charge controller**

12 volt solar charge controller (for overloading, short circuit, reverse discharging and, reverse polarity protection)

**Battery**

12 volt rechargeable battery

**Water pump**

12 volt DC submersible water pump

**Switch- PN2222A BJT Transistor**

12 volt battery is connected to 12 volt DC submersible water pump through PN2222A BJT transistor

**Microcontroller**

Raspberry Pi-3 microcontroller- powered by USB/adapter which comes along with controller

Power consumption: 5V, 700 mA, 3.5 watts

Recommended Language- Python

**Sensors**

Ultrasonic sensor – HC-SR04 (to measure the water level in the water tank)

12 volt Battery monitoring sensor – ZSSC1856 (to detect the remaining capacity (SOH) in battery)

### **Cloud platform**

Cloud platform is required to upload all the sensor information to the cloud and, to control the motor through android application.

### **3. The process can be divided into three sections**

14 Water tank section

15 Battery section

16 Application/control section

#### **3.1 Water tank section**

##### **Sensing and displaying**

Sensing the water level in water tank by water level sensor (ultrasonic sensor- HC SR04) and display it in android application via internet (using HTTP protocol)

##### **Automatic Controlling**

If the water level is below 10% in water tank, then Raspberry Pi-3 microcontroller will automatically turn on the agricultural pump. If water level is more than 98% in water tank, then raspberry pi-3 microcontroller will automatically turn off the agricultural pump.

#### **3.2 Battery section**

##### **• Sensing and displaying**

Sensing the battery level connected to solar panels by battery monitoring sensor (ZSSC1856) and display it in android application via internet (using HTTP protocol)

##### **• Automatic Controlling**

If the battery level is 100% and, if the water level in the water tank is less than 98%, then raspberry pi-3 microcontroller will automatically turn ON the agricultural pump. Once the water level is above 98% and, if the battery level is also charged for 100%, then raspberry pi-3 microcontroller will send a notification to the user via internet (using SMTP protocol)

#### **3.3 Monitor and control section**

The water level and the battery level information from sensors will be uploaded to the cloud. From the cloud, it is able to monitor all the information in the android application via internet. This will help to utilize the solar power effectively. Additionally it is able to turn on/turn off the agricultural pump through android application via internet. (Using HTTP protocol)

## **IV. SOLUTION MICRO ARCHITECTURE**

#### **4.1 Water tank section**

##### **Sensing and displaying**

Ultrasonic sensor (HC-SR04) is used to measure the water level in the water tank. The pin diagram of the sensor is shown in Figure 2. A positive pulse of 10 micro second from the raspberry pi-3 microcontroller to the trigger pin will activate the sensor and emits sound waves. These sound waves will hit the water level in the water tank and return to echo pin. By calculating the travelling time of sound waves through raspberry pi-3 microcontroller, the water level in the water tank is calculated.

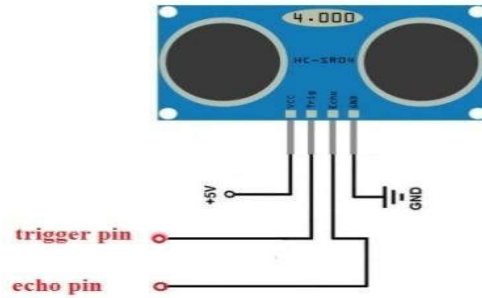

Figure 2: Pin diagram of ultrasonic sensor

Once the water level in the water tank is calculated, raspberry pi-3 microcontroller will upload it to the cloud. From the cloud, using HTTP protocol, water level is monitored through android application in the mobile phone. The connection diagram of ultrasonic sensor to the raspberry pi-3 microcontroller is shown in Figure 3.

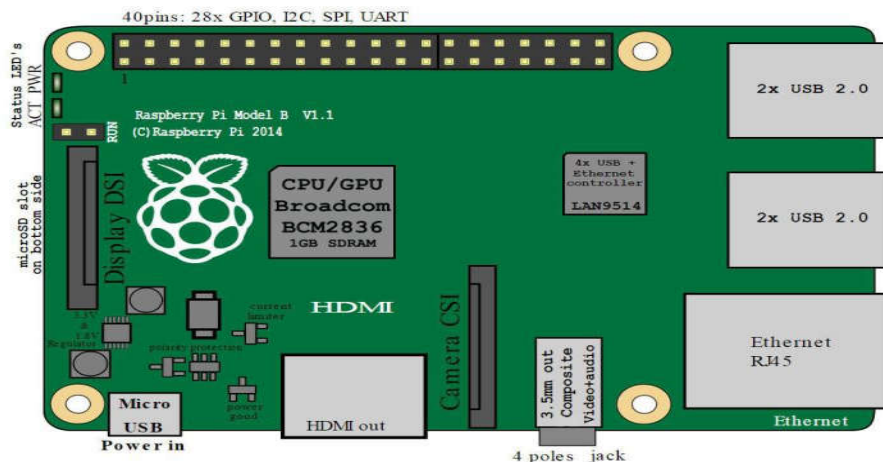
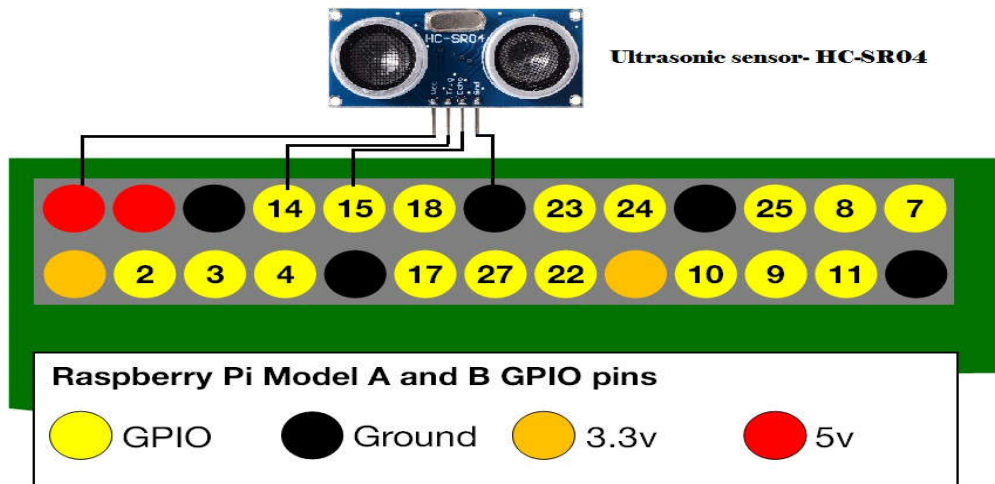

Figure 3: Connection Diagram of ultrasonic sensor to raspberry pi microcontroller

✓ Automatic controlling

If water level in the water tank is less than 10 percent, then raspberry pi-3 microcontroller will activate the GPIO pin 18 in which the water pump will be connected through PN2222A transistor. If water level in the water tank is greater than 98 percent, then raspberry pi-3 microcontroller will deactivate the GPIO pin 18 and there by the water pump will be turned off.

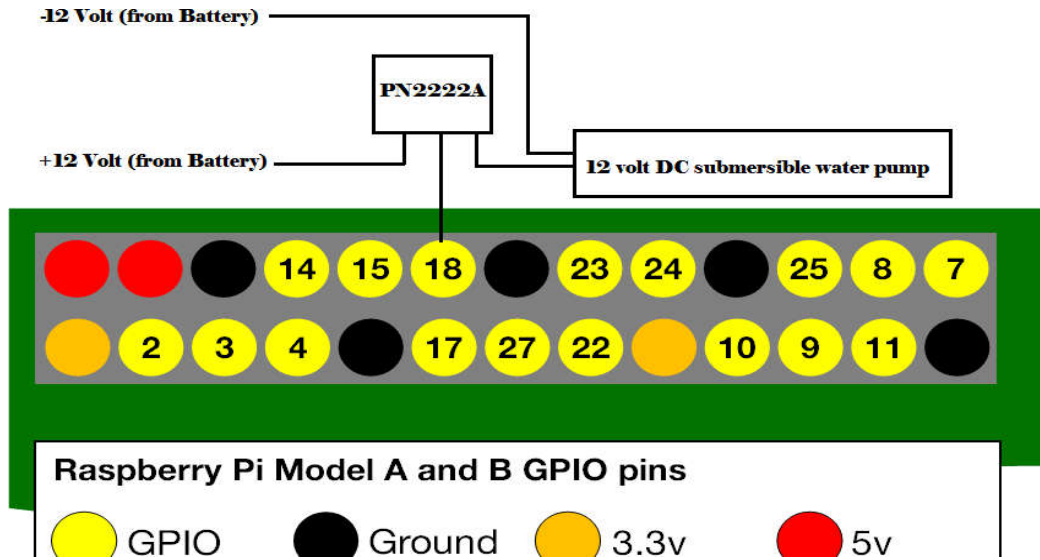

Figure 4: Connection diagram of 12 volt DC submersible water pump to Raspberry pi microcontroller

#### 4.2 Battery Section

##### a. Sensing and displaying

ZSSC1856 is a dual-channel ADC with an embedded microcontroller for battery sensing/management in automotive, industrial and medical systems. One of the two input channels measures the battery current via the voltage drop at the external shunt resistor (R1). The second channel measures the battery voltage and the temperature. Battery level information from ZSSC1856 will be uploaded it to cloud through raspberry pi-3 microcontroller. Connection diagram of ZSSC1856 to Raspberry Pi-3 microcontroller is shown in Figure 5.

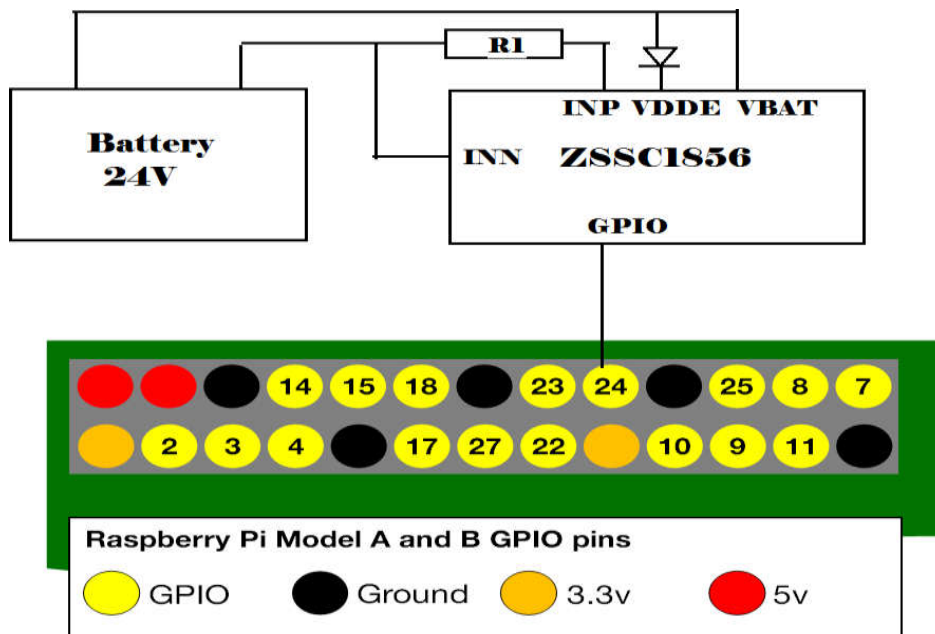

Figure 5: Connection diagram of Battery monitoring sensor (ZSSC1856) to the Raspberry pi-3 microcontroller

##### b. Automatic controlling

If battery level is 100 percent and water level in the water tank is less than 98 percent, raspberry pi-3 microcontroller will activate the GPIO pin 18 by which, it will turn on the water pump. If battery level is 100 percent and, if water level is greater than 98 percent then raspberry pi-3 microcontroller will send notification to the user via internet (using SMTP protocol).

### 4.3 Dashboard and control section

Information from ultrasonic sensor and battery monitoring sensor will be uploaded to the cloud through raspberry pi-3 microcontroller. From the cloud, information can be viewed in android application. Additionally, turn on and turn off button will be provided in the android application to control the water pump via internet. Working model of the android application which we have developed is shown in figure 6.

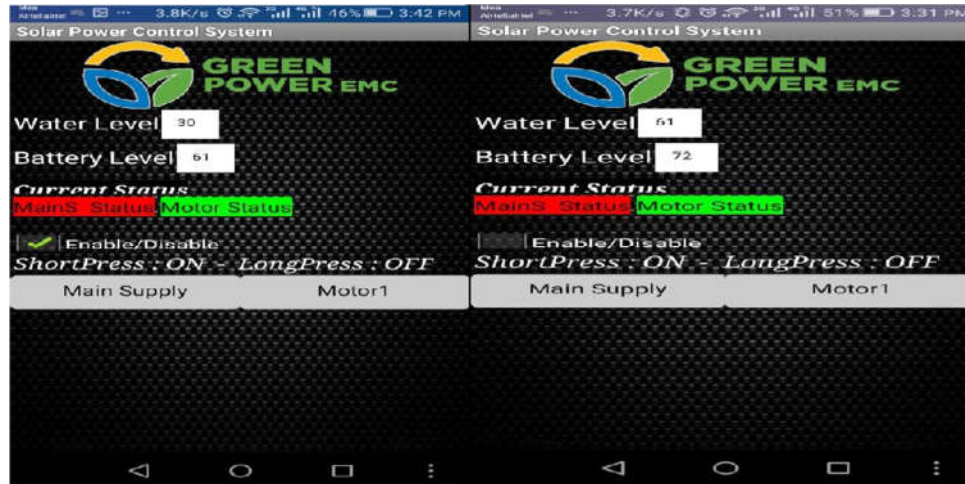

Figure 6: working model of the android application model

## V. HW/SW PARTITIONING

Android application can be develop by android studio IDE (Integrated Development Environment) .

## VI. FUTURESCOPE

Users can save energy in the agricultural pump by sensing and analyzing information such as energy usage and tariff of agricultural pump with respect to date/time in dashboard via internet. The future technologies such as smart meters can also be added to the proposed solution

## VII. MARKET ANALYSIS

The agriculturists having agricultural pump or a need of it are the customers. The controller can be fixed to the old agricultural pump or it is able to sell the brand new agricultural pump with all the mentioned features and controller. For old agricultural pump it is able to add features like water level sensor, battery sensor and providing cloud storage with mobile application and dash board for monitoring and controlling. The customer can save money and at the same time they can effectively use green energy generation from solar panels.

## CONCLUSION

The proposed method is a unique solution for effective usage of solar power and energy saving in the field of agriculture. The future technologies such as smart meters can also be added to the proposed solution

## REFERENCES

- [1]. Rajan Kumar; Bhim Singh, "BLDC Motor Driven Solar PV Array Fed Water Pumping System Employing Zeta Converter", IEEE Transactions on Industry Applications, 2016, Volume: 52, Issue: 3, Pages: 2315 - 2322
- [2]. BezaNegashGetu; Hussain A. Attia, "Automatic control of agricultural pumps based on soil moisture sensing", 2015, AFRICON 2015, Pages: 1 - 5
- [3]. Sangamesh Malgekalyani Bhole, "Rajan Kumar, And Bhim Singh, "Novel, Low Cost Remotely Operated Smart Irrigation System", 2015 International Conference On Industrial Instrumentation And Control (ICIC) College Of Engineering Pune, India.
- [4]. M.F.Mohd Azam, S.H Rosman, M. Mustafa, S.M. Subra Mullisi, H. Wahy, M.H Jusoh, M.I Md Ali, "Hybrid Water Pump System For Hilly Agricultural Site", Control and System Graduate Research Colloquium (ICSGRC), 2016 7th IEEE
- [5]. Kumar Mishra, Bhim Singh, "Solar Powered Water Pumping System Employing Switched Reluctance Motor Drive", Electrical, Electronics, Signals, Communication and Optimization (EESCO), 2015 International Conference on.